



## JUGEND | CONCRETE

- Front und Korpus mit pflegeleichter und strapazierfähiger Kunststoff-Melaminharzoberfläche
- Kleiderschränke, Kommoden und Innenzubehör mit textilem Innendekor
- hochwertige Griffe im Beton-Look, langer Griff mit Bohrabstand 192 mm, kurzer Griff mit Bohrabstand 64 mm
- Drehtüren und Schubkästen (außer Rollcontainer) sind gedämpft



SILENT SYSTEM

### AUSFÜHRUNGEN

Ausführung: **065**  
 Korpus: **Alpinweiß** (M 900)  
 Front: **Alpinweiß** (M 900)  
 Absetzung: **Beton** (M 267)

Ausführung: **943**  
 Korpus: **Alpinweiß** (M 900)  
 Front: **Alpinweiß** (M 900)

Ausführung: **064**  
 Korpus: **Alpinweiß** (M 900)  
 Front / Absetzung: **Beton** (M 267)

Stand 19/02/2018 Technische Änderungen, Modellabweichungen und Druckfehler vorbehalten.





[www.blauer-engel.de/uz38](http://www.blauer-engel.de/uz38)

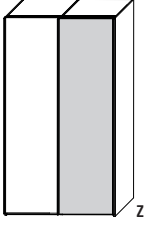
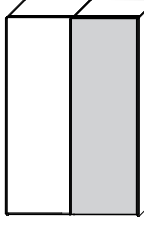

**WELLEMÖBEL**  
 DIE SYSTEMEINRICHTER

# JUGEND | CONCRETE

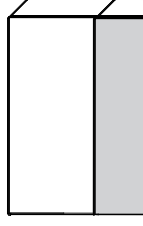

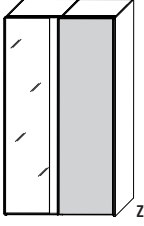
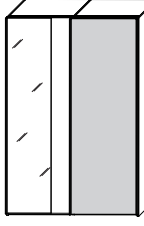

## Schwebetürenschränke

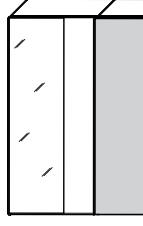
				
Art.-Nr.	<b>34000/065</b>	<b>34001/065</b>	<b>34002/065</b>	<b>34003/065</b>
	Schwebetürenschränk 2-türig, 1 Mittelseite, 4 Einlegeböden, 2 Kleiderstangen, Türen rechts und links verwendbar	Schwebetürenschränk 2-türig, 1 Mittelseite, 4 Einlegeböden, 2 Kleiderstangen, Türen rechts und links verwendbar	Schwebetürenschränk 2-türig, 1 Mittelseite, 4 Einlegeböden, 2 Kleiderstangen, Türen rechts und links verwendbar	Schwebetürenschränk 2-türig, 1 Mittelseite, 4 Einlegeböden, 2 Kleiderstangen, Türen rechts und links verwendbar
Maße B x H x T	125 x 222,5 x 67	150 x 222,5 x 67	175 x 222,5 x 67	200 x 222,5 x 67
EUR				

## Schwebetürenschränke mit Spiegel





				
Art.-Nr.	<b>34004/065</b>	<b>34005/065</b>	<b>34006/065</b>	<b>34007/065</b>
	Schwebetürenschränk 2-türig mit Spiegel, 1 Mittelseite, 4 Einlegeböden, 2 Kleiderstangen, Türen rechts und links verwendbar	Schwebetürenschränk 2-türig mit Spiegel, 1 Mittelseite, 4 Einlegeböden, 2 Kleiderstangen, Türen rechts und links verwendbar	Schwebetürenschränk 2-türig mit Spiegel, 1 Mittelseite, 4 Einlegeböden, 2 Kleiderstangen, Türen rechts und links verwendbar	Schwebetürenschränk 2-türig mit Spiegel, 1 Mittelseite, 4 Einlegeböden, 2 Kleiderstangen, Türen rechts und links verwendbar
Maße B x H x T	125 x 222,5 x 67	150 x 222,5 x 67	175 x 222,5 x 67	200 x 222,5 x 67
EUR				

## Zubehör für Schwebetürenschränke | Einlegeböden





				
Art.-Nr.	<b>34008/001</b>	<b>34009/001</b>	<b>34010/001</b>	<b>34011/001</b>
	Einlegeboden für Schrankbreite 125 cm	Einlegeboden für Schrankbreite 150 cm	Einlegeboden für Schrankbreite 175 cm	Einlegeboden für Schrankbreite 200 cm
Maße B x T	60 x 49,5	72,5 x 49,5	85 x 49,5	97,5 x 49,5
EUR				

# JUGEND | CONCRETE





## Zubehör für Schwebetürenschränke | Kleiderstangen

	 A	 A	 A	 A
Art.-Nr.	<b>34012/001</b>	<b>34013/001</b>	<b>34014/001</b>	<b>34015/001</b>
	Kleiderstange für Schrankbreite 125 cm	Kleiderstange für Schrankbreite 150 cm	Kleiderstange für Schrankbreite 175 cm	Kleiderstange für Schrankbreite 200 cm
Maße B x H x T	B 60	B 72,5	B 85	B 97,5
EUR				



## Zubehör für Schwebetürenschränke | Innenschubkästen



Je nach Schrankbreite können die Breiten der Schubkästen und die Breiten der Blenden variieren!				
	 TA	 TA	 TA	 TA
Art.-Nr.	<b>34016/001</b>	<b>34017/001</b>	<b>34018/001</b>	<b>34019/001</b>
	Innenschubkästen mit 2 Schublen, für Schrankbreite 125 cm	Innenschubkästen mit 2 Schublen, für Schrankbreite 150 cm	Innenschubkästen mit 2 Schublen, für Schrankbreite 175 cm	Innenschubkästen mit 2 Schublen, für Schrankbreite 200 cm
Maße B x H x T	60 x 41,5 x 49,5	72,5 x 41,5 x 49,5	85 x 41,5 x 49,5	97,5 x 41,5 x 49,5
EUR				

## Zubehör für Schwebetürenschränke | Innenschubkästen

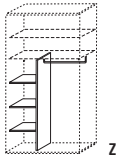
Je nach Schrankbreite können die Breiten der Schubkästen und die Breiten der Blenden variieren!				
	 TA	 TA	 TA	 TA
Art.-Nr.	<b>34020/001</b>	<b>34021/001</b>	<b>34022/001</b>	<b>34023/001</b>
	Innenschubkästen mit 4 Schublen, für Schrankbreite 125 cm	Innenschubkästen mit 4 Schublen, für Schrankbreite 150 cm	Innenschubkästen mit 4 Schublen, für Schrankbreite 175 cm	Innenschubkästen mit 4 Schublen, für Schrankbreite 200 cm
Maße B x H x T	60 x 80 x 49,5	72,5 x 80 x 49,5	85 x 80 x 49,5	97,5 x 80 x 49,5
EUR				

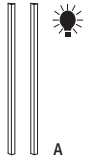

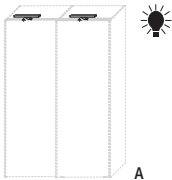

# JUGEND | CONCRETE

Zubehör für Schwebetürenschränke				
				Montage-Set für 1 Schrankfach 
Art.-Nr.	<b>34024/001</b>	<b>34025/001</b>	<b>34026/001</b>	<b>34027/001</b>
	Inneneinteilung mit teleskopierbarer Kleiderstange für Schrankbreiten 175 cm bis 200 cm	LED-Innenbeleuchtung <b>linkes Profil</b> , zur Montage an Außen- oder Mittelseite, inkl. Bewegungsmelder und Trafo, 9,8 W je Leuchte	LED-Innenbeleuchtung <b>rechtes Profil</b> , zur Montage an Außen- oder Mittelseite, inkl. Bewegungsmelder und Trafo, 9,8 W je Leuchte	LED-Innenbeleuchtung <b>rechtes und linkes Profil</b> , zur Montage an Außen- oder Mittelseite, inkl. Bewegungsmelder und Trafo, 9,8 W je Leuchte
Maße B x H x T		H 207	H 207	H 207
EUR				

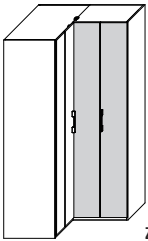
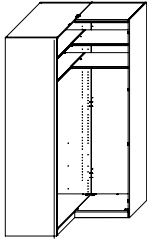
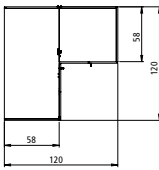
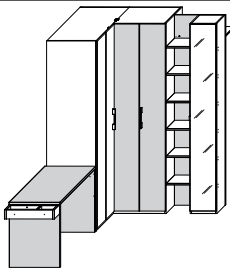
Zubehör für Schwebetürenschränke			
			
Art.-Nr.	<b>34028/001</b>	<b>34029/001</b>	<b>34030/001</b>
	LED-Aufsatzleuchte Quader-Form/ Glaskantenbeleuchtung, 2er-Set, 12V/15W, inkl. Trafo und Fußschalter	Schließungsdämpfer 2-türig	Öffnungsdämpfer 2-türig
Maße B x H x T	B 40		
EUR			

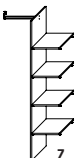

# JUGEND | CONCRETE

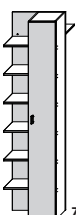
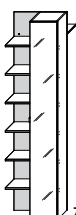
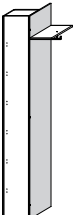

Eck-Kleiderschrank				
				
Art.-Nr.	<b>34031/065</b>	<b>Inneneinteilung</b>	<b>Grundriss</b>	<b>Stellbeispiel</b>
	Eck-Kleiderschrank 1 Falttür, 1 Drehtür, 4 Böden, 2 Kleiderstangen, links und rechts verwendbar			Kombination bestehend aus: Eck-Kleiderschrank Art.-Nr. 34031, Garderobe Art.-Nr. 34036, Schreibtisch Art.-Nr. 34088, Utensilo Box Art.-Nr. 34090
Maße B x H x T	120 x 222,4 x 120			180 x 222,4 x 266
EUR				

Zubehör für Eck-Kleiderschrank				
				
				
Art.-Nr.	<b>34032/001</b>	<b>34033/001</b>	<b>34034/001</b>	<b>34047/001</b>
	Inneneinteilung für Eck-Kleiderschrank Art.-Nr. 34031	Schubkastenelement mit 2 Schubkästen, für Eck-Kleiderschrank Art.-Nr. 34031	Boden für Eck-Kleiderschrank Art.-Nr. 34031	Magnettafel mit 4 Magneten, zur Montage an Kleiderschränken
Maße B x H x T	65,4 x 156,6 x 49,3	43 x 41,7 x 48,8	116,9 x 48,8	44 x 100
EUR				

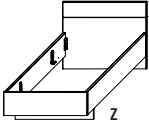
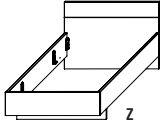
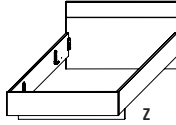
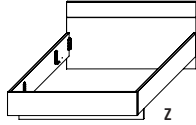
Anstellelemente			
			
Art.-Nr.	<b>34035/064</b>	<b>34036/064</b>	<b>Seitenansicht</b>
	Anstellelement mit Garderobe, 1 Tür (Beton), für Eck-Kleiderschrank, rechts und links verwendbar	Anstellelement mit Garderobe, 1 Spiegeltür, für Eck-Kleiderschrank, rechts und links verwendbar	
Maße B x H x T	60 x 222,4 x 59,6	60 x 222,4 x 59,6	
EUR			



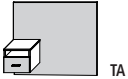
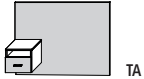
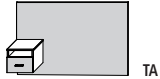

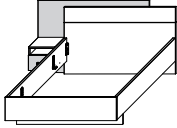

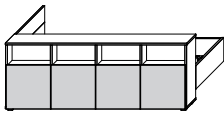
# JUGEND | CONCRETE

Liegen						
 <p>Textiles Zubehör entnehmen Sie bitte der separaten Preisliste!</p>						
	<b>Art.-Nr.</b>	<b>34037/943</b>	<b>34038/943</b>	<b>34039/943</b>	<b>34040/943</b>	<b>34041/943</b>
		Liege Liegefläche 90 x 200 cm	Liege Liegefläche 100 x 200 cm	Liege Liegefläche 120 x 200 cm	Liege Liegefläche 140 x 200 cm	Nachtkommode 2 Schubkästen, Push-to-open
	<b>Maße B x H x T</b>	96 x 76,2 x 205	106 x 76,2 x 205	126 x 76,2 x 205	146 x 76,2 x 205	53,6 x 37 x 39,5
	<b>EUR</b>					



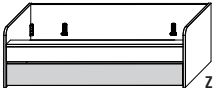

Nako-Paneel						
 <p>Textiles Zubehör entnehmen Sie bitte der separaten Preisliste!</p>						
	<b>Art.-Nr.</b>	<b>34042/064</b>	<b>34043/064</b>	<b>34044/064</b>	<b>34045/064</b>	<b>Stellbeispiel</b>
		Nako-Paneel für Liege Art.-Nr. 34037, rechts und links verwendbar	Nako-Paneel für Liege Art.-Nr. 34038, rechts und links verwendbar	Nako-Paneel für Liege Art.-Nr. 34039, rechts und links verwendbar	Nako-Paneel für Liege Art.-Nr. 34040, rechts und links verwendbar	Kombination bestehend aus: Liege Art.-Nr. 34039 und Nako-Paneel Art.-Nr. 34044
	<b>Maße B x H x T</b>	96 x 82 x 34,7	106 x 82 x 34,7	126 x 82 x 34,7	146 x 82 x 34,7	156 x 82 x 206,6
	<b>EUR</b>					

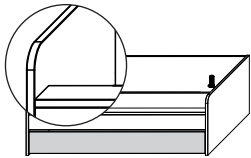
Raumteilendes Sideboard	
	
<b>Art.-Nr.</b>	<b>34046/064</b> <b>Stellbeispiel</b>
	Raumteilendes Sideboard mit 4 Türen und Fächern von beiden Seiten, 4 Einlegeböden
	Kombination bestehend aus: Liege Art.-Nr. 34038 und raumteilendes Sideboard Art.-Nr. 34046
<b>Maße B x H x T</b>	205,4 x 76,2 x 35
<b>EUR</b>	

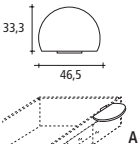
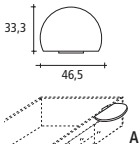

# JUGEND | CONCRETE

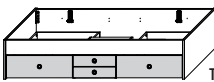
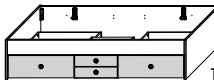
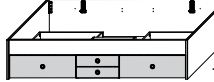
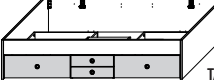

Duoliegen					
					
					
<b>Art.-Nr.</b>	<b>34050/065</b>	<b>34051/065</b>	<b>34052/065</b>	<b>34398/001</b>	<b>Detailsicht</b>
	Duoliege mit seitlicher Ablagefläche, Liegefläche oben 90 x 200 cm, Liegefläche unten 90 x 200 cm, max. Matratzenhöhe im Gästebett 22 cm, Lattenrost im Gästebett nicht möglich	Duoliege mit seitlicher Ablagefläche, Liegefläche oben 100 x 200 cm, Liegefläche unten 90 x 200 cm, max. Matratzenhöhe im Gästebett 22 cm, Lattenrost im Gästebett nicht möglich	Duoliege mit seitlicher Ablagefläche, Liegefläche oben 120 x 200 cm, Liegefläche unten 90 x 200 cm, max. Matratzenhöhe im Gästebett 22 cm, Lattenrost im Gästebett nicht möglich	Weichrollen-Set (6 Stück) zum Austauschen (geeignet für Laminat- und Parkettböden) passend für Art.-Nrn. 34050, 34051, 34052	
<b>Maße B x H x T</b>	205,6 x 65,4 x 105,8	205,6 x 65,4 x 115,8	205,6 x 65,4 x 135,8		
<b>EUR</b>					

Ablageplatten		
		
	<b>Art.-Nr.</b>	<b>34056/943</b>
	Ablageplatte passend zu Betten mit 28 mm Bettseiten (Art.-Nrn. 34037, 34038, 34039 und 34040)	Ablageplatte passend zu Betten mit 22 mm Bettseiten (Art.-Nrn. 34058, 34059, 34060 und 34061)
<b>Maße B x H x T</b>	46,5 x 2,2 x 33,3	46,5 x 2,2 x 33,3
<b>EUR</b>		

Kojenliegen					
					
					
<b>Art.-Nr.</b>	<b>34058/065</b>	<b>34059/065</b>	<b>34060/065</b>	<b>34061/065</b>	<b>34096/001</b>
	Kojenliege mit 2 großen und 2 kleinen Schubkästen, Liegefläche 90 x 200 cm	Kojenliege mit 2 großen und 2 kleinen Schubkästen, Liegefläche 100 x 200 cm	Kojenliege mit 2 großen und 2 kleinen Schubkästen, Liegefläche 120 x 200 cm	Kojenliege mit 2 großen und 2 kleinen Schubkästen, Liegefläche 140 x 200 cm	Weichrollen-Set (8 Stück) zum Austauschen (geeignet für Laminat- und Parkettböden) passend für Art.-Nrn. 34058, 34059, 34060, 34061)
<b>Maße B x H x T</b>	204,4 x 44,1 x 95,4	204,4 x 44,1 x 105,4	204,4 x 44,1 x 125,4	204,4 x 44,1 x 145,4	
<b>EUR</b>					

# JUGEND | CONCRETE

Hängeelemente		
	 TA  TA	<b>Ausführungen Hängeelemente</b> Boden: Alpinweiß <b>065</b> Kubus: Beton <b>943</b> Kubus: Alpinweiß
<b>Art.-Nr.</b>	<b>34062</b>	<b>34063</b>
	Hängeelement mit 1 offenen Fach, rechts und links verwendbar	Hängeelement mit 1 Tür, rechts und links verwendbar
<b>Maße B x H x T</b>	100 x 27,6 x 25,6	75 x 42,3 x 27,5
<b>EUR</b>		





Hängeelemente			
	 A  A  A	<b>Ausführungen Hängeelemente</b> <b>123</b> Beton <b>943</b> Alpinweiß	
<b>Art.-Nr.</b>	<b>34064</b>	<b>34065</b>	<b>34066</b>
	Hängeelement	Hängeelement mit Tür	Hängeelement mit Glastür
<b>Maße B x H x T</b>	35 x 35 x 25,4	35 x 35 x 27	35 x 35 x 25,9
<b>EUR</b>			

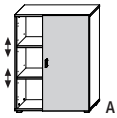
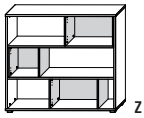

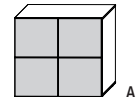
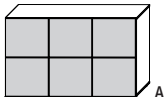
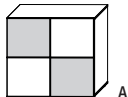
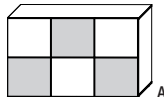

# JUGEND | CONCRETE



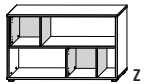
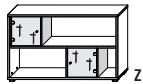
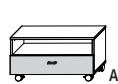

Anbauteile (H 112 cm)		
	 Artikel ist frei im Raum stellbar!	
	 A	 Z
Art.-Nr.	<b>34067/064</b>	<b>34068/064</b>
	Anbauteil mit 1 Tür und 3 offenen Fächern, links und rechts verwendbar	Regal
Maße B x H x T	85 x 111,5 x 34,9	125 x 111,5 x 33,5
EUR		

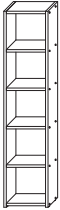
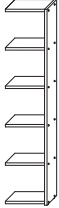
Kommoden (H 82 cm)				
	 A	 A	 A	 A
Art.-Nr.	<b>34048/064</b>	<b>34069/064</b>	<b>34048/065</b>	<b>34069/065</b>
	Kommode mit 4 Türen, 1 Mittelseite, 2 Böden, inkl. Gleiter	Kommode mit 6 Türen, 2 Mittelseiten, 3 Böden, inkl. Gleiter	Kommode mit 4 Türen, 1 Mittelseite, 2 Böden, inkl. Gleiter	Kommode mit 6 Türen, 2 Mittelseiten, 3 Böden, inkl. Gleiter
Maße B x H x T	90 x 81,6 x 41,6	134,4 x 81,6 x 41,6	90 x 81,6 x 41,6	134,4 x 81,6 x 41,6
EUR				

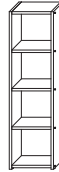
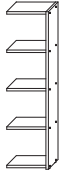
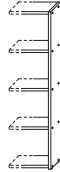
Anbauteile (H 75 cm)				HiFi-/TV-Wagen	
	 Artikel sind frei im Raum stellbar!			 max. Beladung 50 kg	
	 A	 A	 Z	 Z	 A
Art.-Nr.	<b>34070/943</b>	<b>34071/064</b>	<b>34072/064</b>	<b>34073/064</b>	<b>34074/064</b>
	Regal mit 2 offenen Fächern	Anbauteil mit 4 Schubkästen	Regal	Regal mit Glastüren	HiFi-/TV-Wagen mit 1 offenem Fach für Geräte und 1 Auszug, auf Rollen, frei im Raum stellbar
Maße B x H x T	60 x 75 x 33,5	60 x 75 x 34,9	125 x 75 x 33,5	125 x 75 x 33,5	95 x 51,2 x 41,3
EUR					

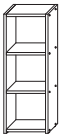
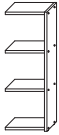

# JUGEND | CONCRETE

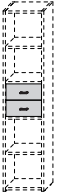

Regalsystem						
 Wangen und Böden in Korpusfarbe						
	Art.-Nr.	<b>34075/943</b>	<b>34076/943</b>	<b>34077/943</b>	<b>34078/943</b>	<b>34079/943</b>
	Regal 5 Fächer, inkl. Stellfüße mit Höhenausgleich	Anbauregal 5 Fächer, inkl. Stellfüße mit Höhenausgleich	Maßausgleichsregal max. 100 cm breit	Regal 4 Fächer, inkl. Stellfüße mit Höhenausgleich	Anbauregal 4 Fächer, inkl. Stellfüße mit Höhenausgleich	Maßausgleichsregal max. 100 cm breit
Maße B x H x T	50 x 220,9 x 33,3	47,2 x 220,9 x 33,3	max. 100 x 220,9 x 33,3	50 x 177,8 x 33,3	47,2 x 177,8 x 33,3	max. 100 x 177,8 x 33,3
EUR						

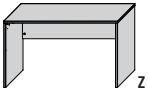
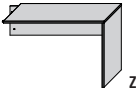
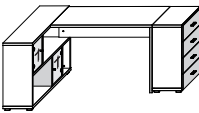

Regalsystem						
 Wangen und Böden in Korpusfarbe						
	Art.-Nr.	<b>34081/943</b>	<b>34082/943</b>	<b>34083/943</b>	<b>34084/943</b>	<b>34085/943</b>
	Regal 3 Fächer, inkl. Stellfüße mit Höhenausgleich	Anbauregal 3 Fächer, inkl. Stellfüße mit Höhenausgleich	Maßausgleichsregal max. 100 cm breit	Regal 2 Fächer, inkl. Stellfüße mit Höhenausgleich	Anbauregal 2 Fächer, inkl. Stellfüße mit Höhenausgleich	Maßausgleichsregal max. 100 cm breit
Maße B x H x T	50 x 134,7 x 33,3	47,2 x 134,7 x 33,3	max. 100 x 134,7 x 33,3	50 x 91,6 x 33,3	47,2 x 91,6 x 33,3	max. 100 x 91,6 x 33,3
EUR						

Regalsystem		
 	<p><b>NEU</b></p>	<b>Ausführungen</b> 123 Beton 943 Alpinweiß
Art.-Nr.	<b>34087</b>	<b>34399</b>
	Tür zwischen 2 Regalböden montierbar, Push-to-open	Schubkasten-Einsatz mit 2 Schubkästen, zwischen 2 Regalböden montierbar
Maße B x H x T	44 x 39,7 x 1,6	44 x 39,7 x 32,3
EUR		

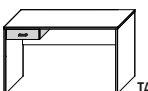
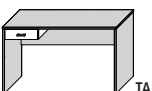
# JUGEND | CONCRETE

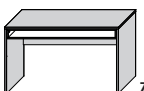
Arbeiten					
					<b>Ausführungen Schreibtische und Rollcontainer</b> <b>123</b> Korpus und Front: Beton <b>943</b> Korpus und Front: Alpinweiß
Art.-Nr.	<b>34088</b>	<b>34093</b>	<b>Stellebeispiel</b>	<b>34089</b>	
	Wangenschreibtisch	Schreibtisch mit Wange, zur Montage an Anbauteilen Art.-Nrn. 34068, 34070, 34072 und 34073	Kombination bestehend aus: Regal Art.-Nr. 34073, Schreibtisch Art.-Nr. 34093, Anbauteil Art.-Nr. 34071	Rollcontainer mit Schloss	
Maße B x H x T	130 x 75 x 60	115 x 75 x 60	183,4 x 75 x 125	42,8 x 55,5 x 50	
EUR					

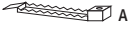
Arbeiten					
					
Art.-Nr.	<b>34091/064</b>	<b>34091/073</b>	<b>34092/064</b>	<b>34092/073</b>	
	Wangenschreibtisch mit 1 Schubkasten	Wangenschreibtisch mit 1 Schubkasten	Wangenschreibtisch mit 1 offenem Fach	Wangenschreibtisch mit 1 offenem Fach	
Maße B x H x T	130 x 75 x 60	130 x 75 x 60	130 x 75 x 60	130 x 75 x 60	
EUR					

Schreibtisch-Zubehör					
					
Art.-Nr.	<b>34090/943</b>	<b>34094/001</b>	<b>34095/001</b>		
	Utensilo Box seitlich montierbar an alle Schreibtische	Kabelklemmen 5 Stück für Kabelführung unter der Arbeitsplatte	Kabeldurchführung Ø 8 cm, Metall chrom-matt zur Selbstmontage an beliebiger Position		
Maße B x H x T	16 x 10,8 x 58,8				
EUR					

# ENERGIEEFFIZIENZÜBERSICHT | CONCRETE



34025/001 Mittel- und Außenbeleuchtung, links

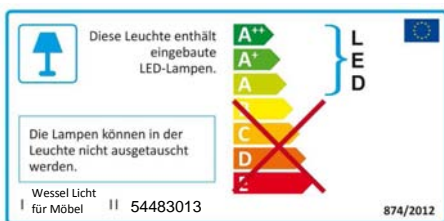

34026/001 Mittel- und Außenbeleuchtung, rechts



34027/001 Mittel- und Außenbeleuchtung, links und rechts



34028/001 LED-Aufsatzleuchte mit Glaskantenbeleuchtung, 2er-Set